

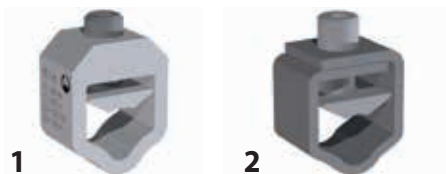



Range / Produktpalette

NH-00 Type / Typ 443



1

2

	References Artikelnummer Art. / Nr.	Type of clamp Anschlussvarianten	Torque Anzugsdrehmoment (Nm)	Cross section / Klemmenquerschnitt (mm ²)			
				 rm	 re	 sm	 se
1	101.01.122	V-Al Terminal V-Al Klemme	15	10-95	10-95	25-120	25-150
2	101.01.114	V-Steel Terminal V-Stahl Klemme	15	10-70	10-70	25-95	20-120

NH-1/2/3 Type / Typ 415/438







1

2

3

4

5

	References Artikelnummer Art. / Nr.	Type of clamp Anschlussvarianten	Torque Anzugsdrehmoment (Nm)	Cross section / Klemmenquerschnitt (mm ²)			
				 rm	 re	 sm	 se
1	101.01.103	Aluminum V-terminal with reversible pressure pad V-Klemme, Aluminium, mit wendbarem Druckkissen	25	16-185	16-240	35-240	35-300
2	101.01.110	Aluminum V-terminal V-Klemme, Aluminium	25	35-240	35-150	35-240	50-240
3	101.01.109	Aluminum V-terminal with shear head screw V-Klemme, Aluminium, mit Scherkopfschraube	25	25-240	35-150	25-240	50-240
4	101.01.66	Steel V terminal V-Stahlrahmenklemme	40	35-120	35-150	50-185	50-240
5	101.01.120	Steel V terminal V-Stahlrahmenklemme	35	35-300	35-185	35-240	50-300

Dimensions / Abmessungen

9

NH-00 Type / Typ 443

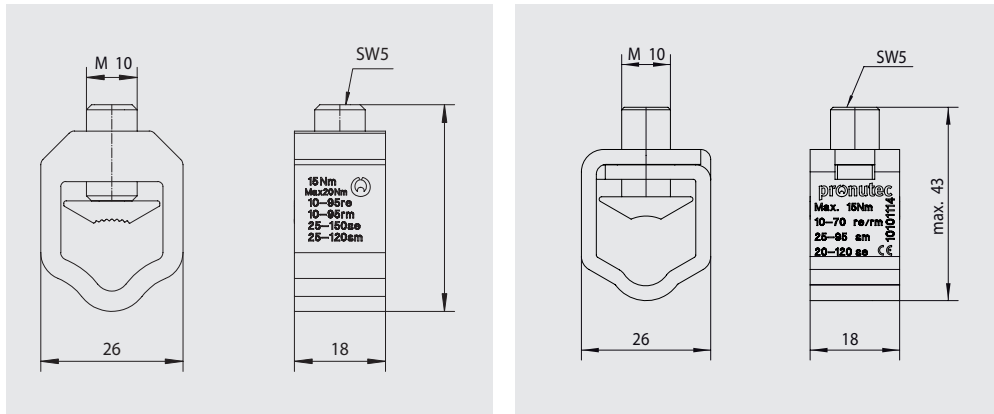

NH-1/2/3 Type / Typ 415/438

